



FOODSERVICE

Owner's Manual

Read And Save These Instructions



PORTION BLENDING SYSTEM™

Portion Control Ice Shaver Blender

All Models

IMPORTANT SAFEGUARDS

1. Read all instructions.
2. To protect against risk of electrical shock, do not put shaver base in water or other liquid.
3. Close adult supervision is necessary when appliance is used by or near children.
4. Unplug the power cord from the wall outlet when the Portion Blending System™ (PBS) is not in use, before putting on or taking off parts, and before cleaning other than washing the container.
5. Appliance must be positioned so the power cord plug is accessible.
6. The PBS must be plugged into its own dedicated power supply or outlet.
7. Never contact moving parts.
8. Do not operate any appliance that malfunctions, has a damaged cord, or plug, or that has been dropped or damaged in any manner. **Call Vita-Mix® Service, (1-800-886-5235) or 440-235-0214** at once for possible replacement, examination, repair, electrical or mechanical adjustment.
If you live outside the US, contact your local Vita-Mix Distributor, or phone the Vita-Mix International Division at +1 (440) 235-5494 or email at international@vitamix.com for a distributor in your country.
9. The use of attachments not recommended or sold by Vita-Mix Corporation may cause fire, shock, or injury.
10. **Do not use outdoors.**
11. Do not let the power cord hang over edge of table or counter, or touch hot surfaces.
12. Keep hands and utensils out of the ice bin and container while motor is running to prevent the possibility of severe personal injury and/or damage to the PBS. A rubber scraper may be used in the container, but only when the PBS is not running.
13. Do not fill ice bin with any other substance but ice.
14. **CAUTION: Ice shaver blade is sharp. Handle carefully.** Do not operate with loose, nicked or damaged blades.
15. Do not disconnect ice bin interlock. Doing so may lead to serious injury.
16. **CAUTION: Container blade is sharp. Handle carefully.**
 - Never try to remove blade while container is sitting on the shaver base.
 - Do not operate with loose, nicked or damaged blades.
 - To reduce the risk of personal injury, never place blade assembly on shaver base without blender container properly attached.

17. The maximum capacity is equivalent to the ounces (liters) listed on the container, i.e. 64 oz. (2 liters), 48 oz. (1.4 liters), and substantially less with thick mixtures.
18. Do not use more than 5 cups (1.3 liters) of cleaning solution when cleaning the ice bin. See Care and Cleaning Instructions, page 20.
19. Always operate the blender with the splash guard or two piece lid in place.
20. Display window area will scratch when contacted with a scouring pad or sharp object. Use a soft cloth to wipe the control panel area clean.

SAVE THESE INSTRUCTIONS

Enjoy the safety of this grounded appliance. The Portion Blending System™ US power cord comes equipped with a three-prong (grounding) plug which mates with a standard three-prong wall outlet (Figure A). This cord will vary for countries outside the United States.

Adapters (Figure B) are available for two-prong outlets. Do not cut or remove the third (ground) prong from the plug or power cord.

Consult your electrician if you are not sure if the wall outlet is grounded through the building wiring. With a properly grounded two prong wall outlet, ground the PBS by attaching the tab on the adapter to the wall outlet cover by means of the screw in the center of the cover (Figure B).



**THREE PRONG
ADAPTERS
ARE NOT TO
BE USED IN
CANADA.**

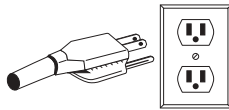

Figure A

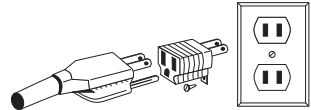
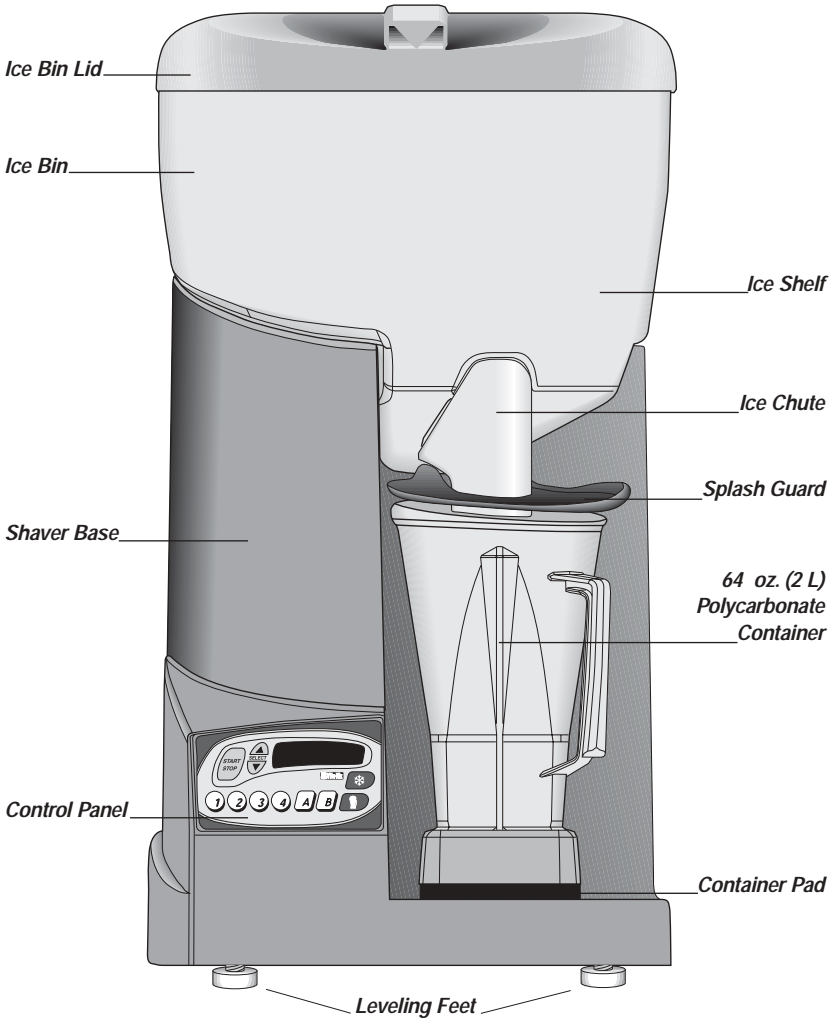

Figure B

The Portion Blending System™ (PBS) is for commercial use ONLY.

Getting Started



Setting Up The PBS

Place the PBS on a sturdy, level surface or counter.

Packaged inside the Ice Bin are items necessary for the operation of the PBS. Remove the Ice Bin Lid and take out the following items:

- Container
- Container Lid with Lid Plug
- Ice Chute
- Drain Kit
- Splash Guard
- Drive Socket Kit

Level Feet Adjustment - Use a level and adjust the feet on the bottom of the machine to level your PBS on the counter. With the Ice Bin Lid removed place a level on top of the Ice Bin while adjusting the feet. Turn the feet to raise or lower the machine and use the adjustment nut to tighten and lock them in place.



DO NOT unscrew the feet so that the threads of the feet become exposed.

Splash Guard - The Splash Guard attaches to the Ice Chute and is used to loosely cover the container during operation (Figure A). The Splash Guard should not touch the container.

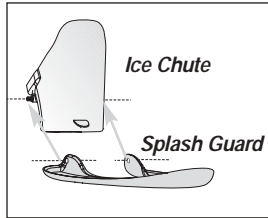

Figure A

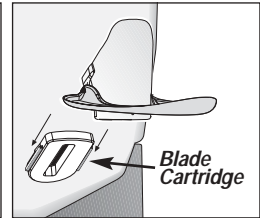

Figure B

Ice Chute - Slide the Ice Chute and Splash Guard over the Blade Cartridge located on the underside of the Ice Bin (Figure B). The Ice Chute and Blade Cartridge will click and lock together indicating proper placement.

Ice Shelf Placement

⚠ WARNING: To reduce the risk of injury unplug the unit before reaching inside the ice bin. Do not operate without lid in place.

The Ice Shelf rests inside the Ice Bin and helps separate and distribute the ice cubes for shaving. The shelf may have shifted during shipping and unpacking and should rest level inside the Ice Bin with the inner lip facing down. The Ice Shelf will be removed for cleaning but should always be properly replaced before adding ice.

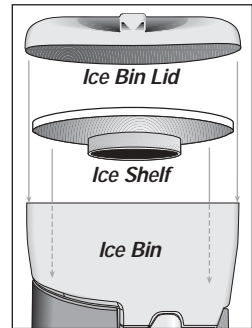

Drain Hose Installation

Drain Hose - The drain hose is attached to the bottom of the machine. The opposite end of the hose extends about 5' (1.5 m) and will need to be placed in a sink or bucket. **The end of the hose must not be submerged in water at any time.** Also, the drain hose must be free of kinks and bends and must not rest above the level of the drain hole located just behind the container. See 'Using the Drain Hose Kit' on the next page, for further instructions.

CONTINUED ON PAGE 6

Getting Started

CONTINUED FROM PAGE 5

Using the Drain Hose Kit

The Drain Hose Kit contains one 90° elbow and two hose clamps. When routing to a sink, bucket, or similar receptacle use the Drain Hose Kit to eliminate possible kinking of the drain hose. Kinking can be caused by a sharp 90° bend created by the edge of a counter.

1. Once the machine is positioned on the counter, run the drain hose from under the machine to a proper drain receptacle.
2. Cut the hose at the point it reaches the end of the counter.
3. Place one clamp over the end of the hose coming from the machine. Connect the two ends of the drain hose onto the elbow of the Drain Hose Kit. The elbow should rest over the edge of the counter.
4. Place the other clamp over the end of the hose and slide it up to the newly positioned elbow. Position both clamps at each end of the elbow and tighten with a screw driver.
5. Reposition the PBS so that the elbow rests properly against the edge of the counter.

NOTE: If the position of the machine on the counter changes it may be necessary to replace the Drain Hose to avoid kinks. Readily available, standard 1/2" (13 mm) plastic pipe and fittings may be used for more complex installations.

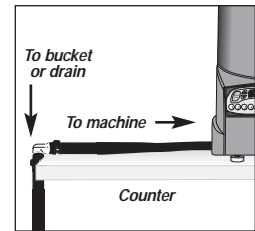
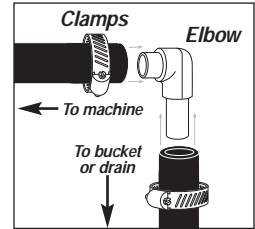

Cleaning the Ice Bin

After removing the contents packed in the Ice Bin, an initial cleaning and sanitizing will be necessary before adding ice. Make sure the Drain Hose is connected, and that there is power to the machine before cleaning the Ice Bin.

- Follow steps 2-11 on page 20 'Care & Cleaning: Ice Bin'

Once dry, replace the Ice Shelf, Ice Chute and Splash Guard.

Filling The Machine With Ice

With the Ice Bin Lid removed and the Ice Shelf in place, you can fill the Ice Bin with up to 5 gallons (19 liters) of cubed ice.

- Using ice from an ice-making machine works best in the PBS.
- Shape and size of the ice cube will not affect the machines operation.
- Do NOT use block ice.

- Avoid using bagged ice that has been stored in a freezer at extremely low temperature. Use of this type of ice may result in freeze-up of the shaver. When you must use bagged ice, it should be stored in an ice chest for a least an hour before use.

Replace the Ice Bin Lid and your machine is ready for use.

Ice Bin Lid



NOTE: For the Ice Shaver to work the Ice Bin Lid must be positioned properly on top of the Ice Bin.

Each time ice is added to the Ice Bin or when the Ice Bin is cleaned the lid must be replaced properly or the machine will not shave ice. A safety interlock switch is located on the Ice Bin and is deactivated when the lid is placed in its correct position on top of the bin.

1. When replacing the lid align the mark on the front of the lid with the mark on the ice bin.
2. With both hands press down on two sides of the lid.
3. Check to make sure the back of the lid is flush with the lip of the Ice Bin.

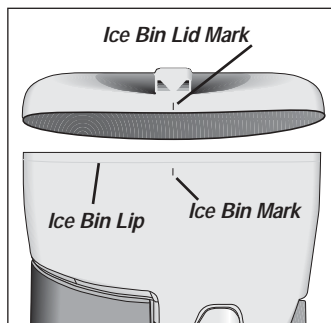

Container Two-Piece Lid Assembly

The Two-Piece Lid is used when cleaning the container or using the PBS as a variable speed blender only. (See page 11 for instructions on using the PBS as a variable speed blender.)

The Two-Piece Lid is easy to clean and easy to put on and take off. (**NOTE:** Brand new lids are a little stiff. This is temporary.)

- The lid has a continuous rim which latches inside the container tabs. Push one side of the rim under one tab, and with the heel of your hands push down, over the opposite tab, to snap lid into position.
- To remove lid, place hands around the lid, pressing thumbs above one of the container tabs. Push in and lift off.
- Twist the center Lid Plug to fasten or remove.

To secure lid plug, rotate it so one tab locks between the stops on top of rubber lid.

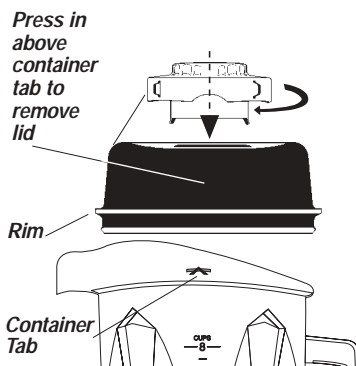

Figure B

Container Pad

Make sure the Container Pad is positioned correctly by firmly pressing down on all four sides.



Do not remove the container pad unless it is damaged. See page 20 for cleaning around the Container Pad.

For instructions on using the Control Panel turn to page 8.

For Operating Instructions turn to page 10.

Control Panel

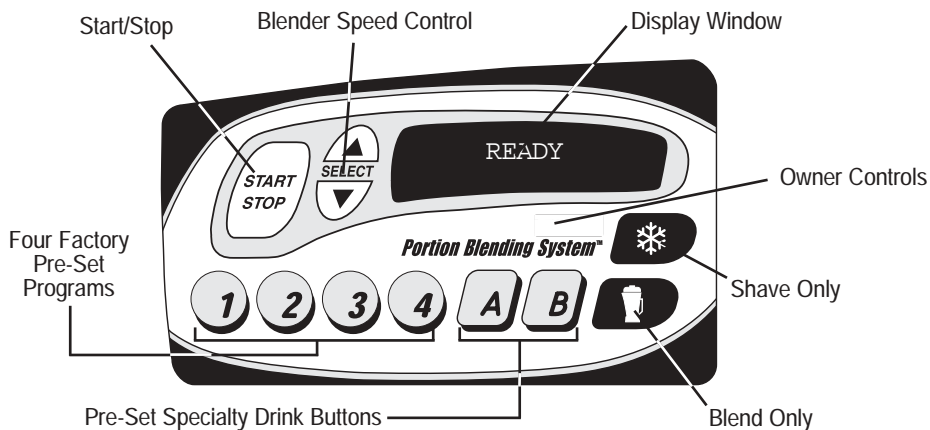

Portion Blending System™



ON/OFF switch - Located on the back of the machine the ON/OFF switch controls the power to the PBS. With the machine plugged in, switch the machine to ON to ready the machine for shaving ice and blending.

START/STOP button - Pressing START/STOP once *starts* and *runs* only the blender on the PBS. While the blender is running you may add ice by pressing and holding the SHAVE ONLY button. Release the SHAVE ONLY button to stop adding ice. Press the START/STOP button again to *stop* the blender and the container blades.

(NOTE: Pressing one of the PRE-SET PROGRAM buttons or the PRE-SET SPECIALTY DRINK buttons, while the motor is running, will also stop the machine.)

BLENDER SPEED CONTROL button - Press the ▲ button to gradually *increase* the speed of the blender blades in increments of 1%, up to 100%. Press the ▼ button to gradually *decrease* the speed of the blender blades in increments of 1%, down to 7%. SPEED CONTROL is used to set the blending speed of the BLEND ONLY button and the START/STOP button. NOTE: These settings will reset if the power is shut off.

PRE-SET PROGRAM buttons - These buttons, numbered 1 thru 4, are pre-programmed blending cycles designed for your most commonly made drinks. These four buttons would commonly be programmed to produce from one to four 12 oz. (355 ml) drinks. (Button 1 builds one 12 oz. (355 ml) drink, Button 2 builds two 12 oz. (355 ml) drinks, etc.) Pressing one of the four PRE-SET PROGRAM buttons will run the machine for a full cycle. The machine will stop by itself when the cycle is complete. A cycle varies in ice weight and in speed and length, see Instructions on page 10 for a complete description of the range of each PRE-SET button. See page 12 for information on Custom Programming these four buttons.

PRE-SET SPECIALTY DRINK buttons - These buttons, A thru B, are also pre-programmed blending cycles designed for specialty drinks, drinks of the week, and secret recipe drinks. See page 10 for instructions on using the SPECIALTY DRINK buttons. See page 12 for information on Custom Programming these buttons.

SHAVE ONLY button - Allows the operator to add more ice after a shave/blend cycle or even shave ice without the blender running. Press and hold the SHAVE ONLY button to dispense ice. Shaved ice will be dispensed until the button is released. **NOTE:** The container must be in place. Avoid overfilling the container.

BLEND ONLY button - Allows the operator to use the blender motor without adding any ice. Place the container on the machine, press and hold the BLEND ONLY button. The blender will run until the button is released. **NOTE:** While holding down the BLEND ONLY button, use the BLENDER SPEED CONTROL buttons to adjust the motor speed.

DISPLAY WINDOW - This area depending on what button is pressed, displays a variety of operation messages. A 'READY' message appears when there is power to the machine.



OWNER CONTROLS - A control panel accessible by pressing the Vita-Mix logo.









- **Press once** to reveal the mode message. Press Button 1 then B within five seconds to continue. Once the correct code is entered the display will indicate the blender motor temperature ('NORM' or normal, 'WARM', 'HOT'), a usage count and a total. The 'COUNT' is a machine usage total and can be reset. This can be used to keep a count of the number of times the machine has been used in a week, day or even an hour. To clear, press and hold the START/STOP button for 5 seconds. The 'TOTAL' keeps track of the machine usage, including production and testing, and cannot be cleared.
- **Press a second** time to reveal the name of the program controlling the PRE-SET buttons. If you are using the factory settings this will read 'VITA-MIX PBS PROGRAM #X'. (X stands for version number of program)
- **Press a third** time for programming and adjusting the six pre-set buttons shaver settings and blending times. See page 12 for instructions. (**NOTE:** On early 120V models of the PBS this may be the option to reset the PRE-SET buttons.)
- **Press a fourth** time to reveal an option to reset the PRE-SET buttons to the original factory settings. See page 13 for instructions. (**NOTE:** On early 120V models of the PBS this may be the option to adjust the settings of the PRE-SET buttons.)
- **Press a fifth** time to exit and continue blending.

Instructions

Each buttons factory Pre-Set Application.

Use the following chart to determine which button you will need.

NOTE: The chart below uses the factory settings in determining the use of each PRE-SET button (your machines PRE-SET buttons may be different if your PBS was programmed specifically for your business).

	Button 1 will shave enough ice for one 12 oz. (355 ml) drink, when using 5 oz. (145 ml) of liquid cocktail mixes, purees, or coffee liquors only.
	Button 2 will shave enough ice for two 12 oz. (355 ml) drinks, when using 10 oz. (295 ml) of liquid cocktail mixes, purees, or coffee liquors only.
	Button 3 will shave enough ice for three 12 oz. (355 ml) drinks, when using 15 oz. (445 ml) of liquid cocktail mixes, purees, or coffee liquors only.
	Button 4 will shave enough ice for four 12 oz. (355 ml) drinks, when using 20 oz. (560 ml) of liquid cocktail mixes, purees, or coffee liquors only.
	Button A will shave enough ice for one 16 oz. (470 ml) drink, when using 13 oz. (385 ml) of thick mixtures items including, hard ice cream and fresh fruit.
	Button B will shave enough ice for one 16 oz. (470 ml) drink, when using 13 oz. (385 ml) of hard to mix ingredients including, frozen fruit and juice.

How to operate your PBS using one of the Pre-Set Buttons.

1. Place liquids and other ingredients into the machine's container first. Try to avoid running the PBS with the container empty.
2. Set the container on the motor base by aligning it over the rubber centering pad (**Motor must be completely stopped before positioning container**).
3. Make sure there is a sufficient amount of ice in the Ice Bin for the amount of drink(s) being made.
4. Select desired programmed setting by pressing any of the Pre-Set Buttons 1 through 4 or A and B. The machine will immediately begin to cycle through the selected program, shutting off when the program is complete.



The PBS measures the amount of shaved ice by weighing the container. For your PBS to dispense the correct amount of ice **DO NOT** rest your hand or any object against or on the container during the blending or shaving cycle. If you detect a change in the sound of the machine or if a hard or foreign object comes into contact with the blades, do not serve the drink. Inspect your blade assembly for loose, nicked or missing parts. If parts are loose, missing or nicked replace with a new blade assembly. (See page 14.)

5a. When the blending cycle is complete, and more ice is needed, press and hold  the SHAVE ONLY button. By pressing the SHAVE ONLY button more ice will be added to the container. Release the SHAVE ONLY button to stop the shaving of the ice.

NOTE: If you wish to blend the contents of the container while adding the additional ice, press the START/STOP button to start the blender then add more ice by pressing the  SHAVE ONLY button.

5b. If the mix in the container needs more blending press the  BLEND ONLY button and hold for the desired amount of blending. Release the button to stop the blending.

(NOTE: Use the BLENDER SPEED CONTROL buttons to set the speed of the BLEND ONLY button. For example, when the BLEND ONLY button is pressed and held, by simultaneously pressing and holding the ▲ or ▼ BLENDER SPEED CONTROL buttons the motor speed will increase or decrease in 1% increments. When the BLENDER SPEED CONTROL button is released, the BLEND ONLY button will remain set at the selected speed until altered again or until the machine is turned off by the ON/OFF switch or unplugged.

6. When the cycle is complete the blender stops. **Wait until blade comes to a complete stop before removing the lid and/or container from the motor base.**

7. Remove the container, pour, garnish and serve the drink.

Using your PBS as a variable speed blender.

Your PBS machine can be used without dispensing ice from the Ice Bin. The blender motor is powerful enough to blend hard or soft ingredients with just a little bit of liquid.

1. Place liquids and soft foods into the container first, solid or hard ingredients last.
2. With the Ice Chute and Splash Guard in position (see page 5) place the container on the Container Pad. **NOTE:** With the Ice Chute and Splash Guard removed the Two-Piece Lid (see page 7) can also be used during the blend-only process.
3. Press the START/STOP button to run the blender. Adjust the speed of the blender by pressing the BLENDER SPEED CONTROL buttons to increase or decrease the speed.
4. Press the START/STOP button to stop the blending. Wait until the blender comes to a complete stop before removing the container (or lid) from the motor base.
5. Remove the container, pour, garnish and serve the drink.

NOTE: On all units the built-in thermal sensor keeps track of how hot the motor gets and eventually shuts down the motor if the motor is overheating. When overheated the display will instruct the user to remove the container and run the machine until cool. This takes about a minute.

When overheating occurs, review your techniques and instructions. The motor may be overheating if your recipes are too thick. Consider adding more liquid and consult Vita-Mix for further assistance.

For description and uses of the other buttons see the Control Panel section page 8.

For Custom Programming turn to page 12.

For Cleaning & Sanitizing Instructions turn to page 18.

For Troubleshooting turn to page 21.

Custom Programming

The Portion Blending System™ advanced electronic controls can be custom programmed, by either using the Control Panel or an optional programming chip, available from Vita-Mix® for a nominal fee and with a minimum unit purchase. Contact your Vita-Mix representative for more information on a programming chip.

Programming your PBS with the Control Panel

This process will allow you to reprogram any one of the PRE-SET buttons with different blending times and amounts of ice being shaved into the container.

1. When the Display Panel reads 'READY', press the Owner Controls (Vita-Mix Logo) button once to reveal 'MODE', press Button 1 then B, then press the Owner Controls button three more times until the Display Panel reads 'TO MODIFY ENTER 1 THRU B'.
2. Press the button (1-4 or A,B) you wish to adjust.
3. The display will read either 'TIME :__' or 'ICE +__'. To toggle between the two displays press the SHAVE ONLY button.
4. To change the time or increments of ice, press the SELECT buttons ▲ arrow to increase or ▼ to decrease.
5. When desired time or ice changes have been made press the START/STOP button, display will read 'SAVED'. At this point you can either press another program button (1-4, A & B) and alter its shaving and blend time using the instructions above or press the Owner Controls button (Vita-Mix Logo) to return to blending.

Example of Reprogramming. In this example we will be changing the time and amount of iced shaved for Button 1.

1. When the Display Panel reads 'READY', press the Owner Controls (Vita-Mix Logo) button once to reveal 'MODE', press buttons 1 then B, then press the Owner Control button three more times until the Display Panel reads 'TO MODIFY ENTER 1 THRU B'.
2. Press Button 1.
3. 'TIME :30' appears on the display indicating the amount of time the blender will run after the proper weight of shaved ice is achieved. To increase the time to :40 seconds press and hold the ▲ select button until 'TIME :40' appears on the display. If you go too far, press and hold the ▼ select button to decrease the amount of time.
4. To change over to the amount of ice shaved press the SHAVE ONLY button and 'ICE +01' will be displayed.

NOTE: Use the SHAVE ONLY button to toggle between the two displays. For example, pressing the SHAVE ONLY button again will display the 'TIME :40' screen.





5. With the display reading 'ICE +01' press the ▲ select button to increase the amount of ice to an increment of +05 and release the select button. **NOTE:** Range of adjustments will vary from button to button.
6. After the desired changes have been made press the START/STOP button to save the changes, then press the Owner Control button (Vita-Mix Logo) to return to blending and test the adjustments made on Button One.

SUGGESTION FOR CHANGING THE TIME FOR BUTTON 2, 3, and 4:

If Buttons 2, 3, and 4 were also changed, to match the consistency of Button 1 you would add the same amount of time (10 seconds) to each plus 5 seconds for each button.

SUGGESTION FOR CHANGING THE AMOUNT OF ICE FOR BUTTON 2, 3, and 4:

For Buttons 2, 3, and 4 you will need to double, triple and quadruple the increments of change. For example, since you added 4 increments of ice to Button 1 we will need to add 8 increments to Button 2, 12 increments to Button 3, and 16 increments to Button 4.

NOTE: These guidelines are approximate. Experiment to determine the best blending time and quantity of ice for your particular recipe.

Programming your PBS with a Custom Programmed Chip

1. Turn the PBS sideways so that the control panel faces to your right.
2. Slide the PBS to the edge of the counter to reveal the port underneath the machine located below the control panel.
3. Insert the custom programmed chip with the words, "THIS SIDE FACING TO THE FRONT OF THE MACHINE" toward you, into the port located on the bottom of the machine. The Display Window will read 'New Module'.
4. Within 10 seconds the six PRE-SET buttons will be re-programmed and the Display Window will read 'SAVED' then 'READY'. If nothing happens when the programming chip is fully inserted, turn the chip in the opposite direction and try again. If nothing still happens follow the instructions below under 'Resetting the PRE-SET buttons to the original factory setting' then follow steps 3-6 again with the programming chip.
5. Be sure to remove the programming chip and return it to the original package.
6. Press one of the four PRE-SET buttons to reveal, in the Display Window, the name of the program/drink.

Resetting the PRE-SET buttons to the original factory settings

WARNING: Reverting your PRE-SET PROGRAM buttons to the original factory setting, will erase any programming installed with a custom program chip.

1. Enter the Owner Controls (press the Vita-Mix Logo) and press the PRE-SET buttons 1 and B when the Display Window says 'MODE'.
2. Press the Vita-Mix Logo two more times to reveal the instructions on resetting the PRE-SET buttons.
3. Press and hold the Button 4 until the Display Window reads 'RESTORING PLEASE WAIT'. The PRE-SET buttons are now reset to the original factory settings.

Container Blade

Blade Agitator Assembly

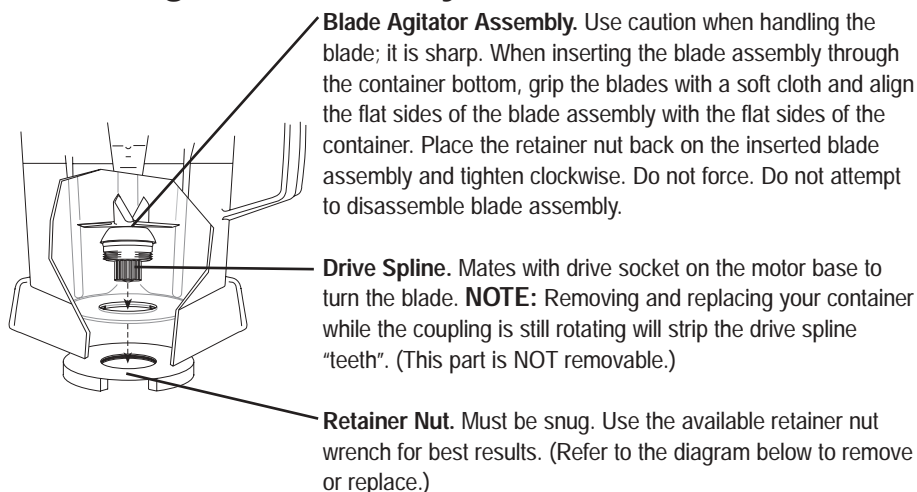

Never use a blade assembly with loose, damaged or knicked components.

Retainer Nut Removal

- The retainer nut is easily removed using a standard 6" (15 cm) screwdriver.* Turn container upside down and insert screwdriver shaft between the lobe and drive spline. Push the screwdriver handle counter-clockwise to loosen nut. Once loosened, remove by hand.
- To replace, position retainer nut on top of blade assembly and hand tighten. Then, using the screwdriver, tighten clockwise until it stops. If it is not tight enough, you will notice increased container noise.

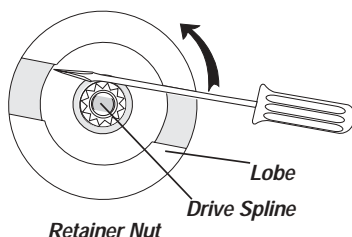

*For best results we recommend using a Retainer Nut Wrench in place of a screwdriver. To order ask for Item #1222



Shaver Blade

Removal and Installation

The PBS Shaving Blade is two blades in one. The blade has two shaving edges so that a fresh edge can be exposed by simply rotating the blade 180°. Your machine was shipped from the factory with a double edged blade installed. The following instructions can be used to either rotate the blade to expose a fresh edge, or to install a new blade (Item #1550).



WARNING: To reduce the risk of injury unplug the unit before rotating or removing the Ice Shaver Blade.



1. Unplug the PBS and remove the Ice Bin Lid, any remaining ice (See page 18 for Ice Removal Instructions), and the Ice Shelf.



CAUTION: When completing the following steps assure that you do not accidentally come in contact with the shaving blade. The blade is extremely sharp and can cause serious injury.



2. Visually locate the position of the Shaver Blade. Grasp the Shaver Wheel so as to avoid the blade, hold the Shaver Wheel stationary while you rotate and remove the Paddle Nut counter clockwise
3. With the Paddle Nut removed lift the Shaver Wheel off of its mounting shaft.
NOTE: If the Shaver Wheel sticks and is difficult to remove, tap the end of the mounting shaft lightly with a hammer to loosen.
4. With the Shaver Wheel removed locate the two screws holding the Shaver Blade, remove the screws and set aside.
5. If the second edge has not been used, simply remove the blade and rotate the blade 180° and replace. **DO NOT TURN THE BLADE OVER.**
6. If a new blade is being installed, discard the old blade and shim and replace with the new blade and shim.
NOTE: Blades and shims must be installed together as a pair to ensure proper PBS operation. When replacing a blade always discard the old blade and old shim and install only all new parts.
7. Securely tighten the two screws. The screws should be flush with the surface of the blade. If the screws are not flush, check that the blade is right side up.
8. Reinstall the Shaver Wheel onto the mounting shaft.
9. Replace the Paddle Nut by holding the Shaver Wheel stationary and turning the Paddle Nut clockwise until snug. Be careful not to come into contact with the Shaver Blade.
10. Replace the Ice Shelf. The PBS is now ready for use.

For Operating Instructions turn to page 10.

For Cleaning & Sanitizing Instructions turn to page 18.

For Troubleshooting turn to page 21.

Parts List

Item#		Description
120/100V	220/240V	
752	752	64 oz. (2 L) - Container with ice blade, no lid assembly
755	755	Lid Plug (for Two Piece Lid)
758	758	64 oz. (2 L) - Container no blade assembly or lid assembly
802	802	Drive Socket Kit - Includes allen wrench & instructions
836	836	Heavy-duty retainer nut
1151	1151	Agitator Assembly (ice blades)
1152	1152	Agitator Assembly (wet blades)
1191	1191	Two Piece Lid
1192	1192	Lid Only (no plug)
1222	1222	Retainer nut wrench
1550	1560	Shaving Blade with Shim
1551	1551	Drain Hose Kit (Includes hose, clamps, and plastic elbow)
PLS503	PLS503	Ice Shelf
PLS504	PLS504	Ice Bin Lid
PLS509	PLS509	Splash Guard
PLS511	PLS511	Ice Chute
RBB502	RBB502	Rubber Container Pad
RBB506	RBB506	Drain Hose
CST500	CST500	Paddle Nut

NOTE: Other than the parts listed above, this unit is not user serviceable.

For Shaver Blade Replacement turn to page 15.

For Container Blade Replacement turn to page 14.

For Drain Hose Kit usage turn to page 6.

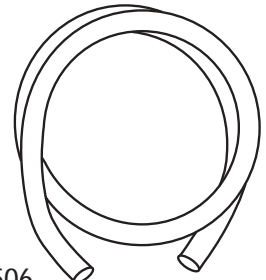
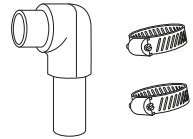
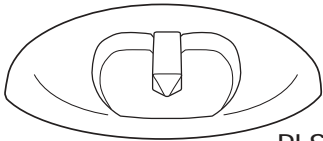
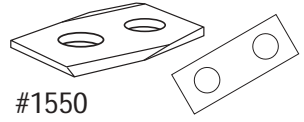
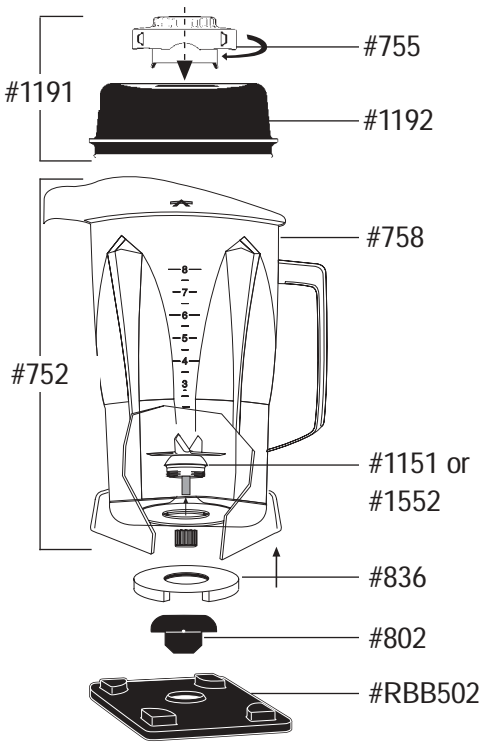

PLS504

#1551

CST500

PLS503

RBB506

Care & Cleaning

Removing Ice from the Ice Bin



WARNING: To reduce the risk of injury unplug the unit before removing ice from the Ice Bin. Do not operate without lid in place.



1. With the machine off and unplugged remove the Ice Bin Lid.
2. Use an ice scoop to remove as much ice as possible from above the Ice Shelf.
3. Remove the Ice Shelf and pour in 8 cups (1.9 liters) of warm water in a circular motion in the Ice Bin and allow to drain.

Care Note

To ensure that you get the longest possible life from your Vita-Mix® product, we recommend the following products, when used as directed by the supplier:

Cleaning Product

Solid Supra, Solid Power,	Ecolab, Inc., St. Paul, MN
Guardian Acclaim, Solid Guardian Plus,	Tel: (800) 352-5326;
Solid Super Impact, Solid Insure	www.ecolab.com
Diverpak	Diversey
Eclipse H2	Livonia, MI
Liqui-Safe L7	Tel: (800) 521-8140
Acclean	Klenzade Products, Division of Ecolab
Poly-Brite	St. Paul, MN
	Tel: (612) 293-2165
Glow MB-1	Wesmar Company, Inc., Seattle, WA
Lustre NC-25	Tel: (206)783-5344;
Lustre Plus	www.wesmar.com
PSRA 41-D, PSRA 41-E	Anderson Chemical Co.
Liqui-Ware 1, Liqui-Ware MC	Litchfield, MN
D-Flex, Sur-Met	Tel: (800) 366-2477
	www.andersonchemical.com

Supplier

Rinse Aids

Solid Rinse Dry	Ecolab, Inc., St. Paul, MN
Solid Brilliance	Tel: (800) 352-8140
Jet Dry, Rinse Dry	www.ecolab.com

Supplier

Destainer

NuWare	Diversey
	Livonia, MI
	Tel: (800) 521-8140

CARE NOTE: Do not let mixtures, liquids and food products dry inside the container. Rinse throughout use. Drying product may lock around the blade and weaken/tear the bearings seal when restarted. Do not place containers in the freezer. Extremely low temperature combined with hot ingredients and/or the immediate rapid action of the blade may crack the container. The Splash Guard, Ice Chute, Ice Shelf, and Thermoplastic Rubber Lid are dishwasher safe. However, to prolong the life of these parts, Vita-Mix® recommends using a low pH balance soap. For maximum container life, do not wash in a dishwasher.

Shaver Base

1. Unplug the power cord.
2. Wash outside surface with a damp soft cloth or sponge, which has been rinsed in a mild solution of liquid dish soap and warm water. **NEVER IMMERSER SHAVER BASE IN WATER OR OTHER LIQUID.**
3. Polish with a soft cloth.

Control Panel

1. Unplug the power cord.
2. Gently wash the front panel with a soft cloth and a low pH balance soap, being careful not to scratch the Display Window.

NOTE: Be sure to wring excess water out of cloth or sponge when cleaning around the controls, drive socket or any electrical part.

Container

1. *To clean:* Fill container 1/4 full with warm (110°F/43°C) water and add a couple drops of dish soap. Return container to motor base and firmly position the two piece lid. **CAUTION: Do not operate without lid in place.** Use the START/STOP button to run the blender for 30 seconds. Empty container. Repeat this step.
2. *To rinse:* Fill pitcher 3/4 full with warm (110°F/43°C) water (do not add soap). Return container to container pad and firmly position the lid. **CAUTION: Do not operate without lid in place.** Run machine for 30 seconds. Empty container.
3. If any solid residue remains, remove the blade agitator assembly (see page 14) and wash all container parts in warm soapy water. Rinse and drain. Reassemble before next step. **DO NOT SOAK** the blade agitator assembly.
4. *To sanitize:* If all solid residue is gone after step 2 or after completion of step 3, fill container 3/4 full with a sanitizing solution mix.* Return container to container pad and firmly position the lid. **CAUTION: Do not operate without lid in place.** Run machine for 30 seconds. Empty container.
5. Return container to container pad and run machine empty for an additional 5 seconds. Do not rinse after sanitizing. Allow container to air dry.

*Recommended sanitizing solution: 1.5 teaspoons institutional bleach in 2 quarts (1.9 liters) water.



Important: Check your blades daily for loose, knicked or missing parts. If you find something is loose, knicked or missing, replace the blade assembly before use. Do not tighten hex-headed screw (on top of blade assembly). If loose, replace blade assembly.



Care & Cleaning

CONTINUED FROM PAGE 19

Ice Chute & Splash Guard

Remove and separate the chute and guard from the Ice Bin, then wash in warm soapy water. Rinse clean under running water and dry. Reassemble before use. (See pages 5).



WARNING: To reduce the risk of injury unplug the unit before removing ice from the Ice Bin. Do not operate without lid in place.



Ice Bin

1. *To clean:* Empty out the remaining ice before cleaning. (See page 18 for ice removal instructions.)
2. Remove the Ice Shelf and wash in a cleaning solution. Rinse clean under running water and dry.
3. Fill a clean blender container with 5 cups (1.2 liters) of a cleaning solution.
4. With the Ice Chute, Splash Guard and Ice Shelf removed, slowly pour the cleaning solution into the Ice Bin in a circular motion, as close to and as high up the inside walls as possible, without splashing solution on the outside of the unit.
(NOTE: Some of the cleaning solution will dispense out of the blade area and the area above and behind the container pad, this is normal.)
5. Immediately replace the container onto the container pad and replace the Ice Bin Lid on top of the Ice Bin. Press and hold the  Shaver Button to run the shaver and circulate the cleaning solution while cleaning fluid is still in the Ice Bin.
6. Hold the Shaver Button for 30 seconds.
7. Release the Shaver Button and allow the cleaning solution to drain out of the Ice Bin.
8. Using a soft cloth soaked in the cleaning solution, manually wipe as much of the Ice Bin and the Shaver as possible. **Use caution when wiping near the Shaver Blade.**
9. Repeat steps 3-7 a second time with the cleaning solution.
10. *To rinse:* Repeat steps 3-7 two times with clean water.
11. *To sanitize:* Repeat steps 3-7 two times using a sanitizing solution.*
12. Do not rinse or wipe down the inside of the ice bin after sanitizing. Allow ice bin to air dry with the lid removed.
13. Remove the lid and wash in a cleaning solution. Rinse clean under running water and dry.

*Recommended sanitizing solution: 1.5 teaspoons institutional bleach (or equivalent) in 8 cups (1.9 liters) water.

Container Pad Area

1. Unplug the power cord.
2. Wash outside surface with a damp soft cloth or sponge, which has been rinsed in a mild solution of liquid dish soap and warm water.
3. Lift the corners of the pad, being careful not to lift it over the drive socket, and wash under the pad as necessary. Polish with a soft cloth.
4. Replace the pad by pressing firmly down all around the edges and corners of the pad.
The Container Pad will 'click' back into place.

Troubleshooting

If you cannot fix your machine with these suggestions, technical help is available by calling the Vita-Mix Service Hot Line at 1-800-886-5235, or emailing PBSservice@vitamix.com.

For customers outside the US and Canada please contact your local Vita-Mix distributor.

1. Problem:

- Drinks not fully blended or have improper consistency.

Solution:

Change blending time or ice quantity. See page 12 for instructions.

2. Problem:

- Quantity of ice dispensed varies and is not consistent.

Solution #1:

Clean center hole of drive socket.

Solution #2:

Replace drive socket if worn or loose.

Solution #3:

Clean the gap between the rubber container pad and the machine housing.

Solution #4:

Make sure the Splash Guard is not touching the top of the container. (See page 5 for proper Splash Guard placement.)

Solution #5:

Check to make sure that the PBS is level and sitting on a solid, sturdy surface.

3. Problem:

- Machine is flooded, and/or water is on the counter.

Solution #1:

Check to assure that the end of the drain hose is not submerged in water.

Solution #2:

Check for proper installation of the drain hose. (See page 7 for instructions.)

4. Problem:

- Increased blender vibration.
- Leaking from bottom of blender container.
- Increased blender container noise.

Solution #1:

Check blade assembly for loose, damaged or knicked components and replace.

Solution #2:

Tighten retainer nut with screwdriver, turning it clockwise until snug.

5. Problem:

- Loud noise from blender container blade area.
- Container blades do not spin.

Solution:

Drive Socket may be broken. Check for a fine crack down the center or worn teeth. Replace with a new drive socket. (Item # 802). Instructions are included with part.

6. Problem:

- Machine will not run.
- Display screen does not say 'READY'.

Solution #1:

Double-check to make sure power cord is firmly in power outlet.

Solution #2:

Check to make sure the ON/OFF switch is in the ON position.

Solution #3:

Machine will not run unless the Ice Bin lid is placed properly back into position to engage the safety interlock switch.

Solution #4:

Turn the ON/OFF switch to off, then on, to reboot the electronics.

Solution #5:

Shaving Wheel may be locked. Reset circuit breaker on back of machine. Remove ice (See page 18) and refill with new ice cubes.

7. Problem:

- Ice shaving too noisy, shaver freezes up.

Solution #1:

Ice is too cold. Do not use bagged freezer ice. Use bin-stored or ice machine ice.

Solution #2:

Shaver blade worn. Turn to expose new edge, or replace. See page 15 for instructions.

8. Problem:

- Display panel reads "NO PROGRAM" when a button is pressed.
- Display panel reads something abnormal.
- Machine is running different.

Solution #1:

Turn the ON/OFF switch to off, then on, to reboot the electronics.

Solution #2:

Reset Programming Buttons to original factory settings. (See Page 13 for instructions.)

9. Problem:

- Display Panel reads 'HOT – SHUTDOWN – REMOVE THE CONTAINER – PRESS START'.

Solution:

This indicates the motor must be cooled. Remove the container from the machine. Press the START/STOP button. Machine will run at a high speed cooling the motor down.

10. Problem:

- Display Panel reads 'POSSIBLY OVERHEATED'.

Solution:

An internal switch turns the motor off until it cools. Let the machine cool down, then start it up again.

11. Problem:

- Display panel reads 'SHUTDOWN SEE MANUAL'.

Solution:

Please contact Vita-Mix.

Specifications

Portion Blending System:

Height of unit: 27 1/2" H (69.85 cm)

Additional height needed above machine for adding ice: 20" (50.8 cm)

Shipping weight (product only): 58 lbs. (26.5 kg)

Dimensions 27 1/2" high x 14 3/4" wide x 16 1/2" deep with lid
(69.85 cm x 37.47 cm x 41.91 cm)

Power Requirements:

Volts: 120 VAC

Volts: 220/240 VAC

Volts: 100 VAC

Amps: 12.0

Watts: 1200-1400

Watts: 950

Hz: 50/60

Hz: 50/60

Hz: 50/60

Service and Support

Warranty Information

Your Portion Blending System, depending on the model purchased, may or may not have a Limited One-Year Warranty provided by Vita-Mix or the distributor in the country (outside the US and Canada) in which your machine was purchased. If your machine has a warranty from Vita-Mix (which would be designated by the item number purchased), please complete and mail back the included warranty card. This card must be on file at Vita-Mix for your machine to be serviced. For customers in the US and Canada, if you have any questions phone your distributor or Vita-Mix at 440-235-0214. If purchased outside the US or Canada please contact your authorized Vita-Mix distributor.

Service Information

All customers in the US and Canada, regardless of warranty status, contact the Vita-Mix Service Hot Line at 1-800-886-5235 or email PBSservice@vitamix.com for service information. For customers outside the US and Canada contact your Vita-Mix distributor for assistance.



VITA-MIX® CORPORATION
Foodservice Division

8615 Usher Road, Cleveland, Ohio 44138

USA

©2002 Vita-Mix Corporation. No part of this publication may be reproduced or transmitted in any form or by any means, electronic or mechanical, including photocopy, recording or any information storage and retrieval system without the written permission of the Vita-Mix Corporation.